

CATALOG NUMBER: E-SZA0DD100 FOR ONE 100 WATT, S54 HIGH PRESSURE SODIUM LAMP

Line Voltage	480V
Regulation	
Line Volts	+/- 5%
Line Watts	WITHIN TRAPEZOID
Frequency	60 Hz
Circuit Type	HX-HPF
Power Factor (min)	90%
Insulation Class	H(180°)
Min. Ambient Starting Temp.	-40° F or -40° C

Line Voltage (Volts)	480
Line Current (Amps)	
Operating	0.28
Open Circuit	0.50
Starting	0.27
Input Watts (W)	128
Open Circuit Voltage (V)	120
Drop Out Voltage (V)	384
UL(1029) Bench Top Rise	A
Recommended Fuse (Amps)	2
HIGH POTENTIAL TEST (VOLTS)	
1 Minute	2000
2 Seconds	2500
Open Circuit Voltage Test(volts)	110-135
Short-Circuit Current Test (Amps)	
Secondary Current	2.4 - 3.0
Input Current (Amps)	0.20 - 0.35

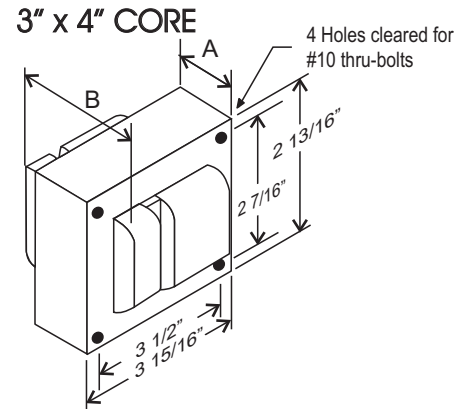

CORE AND COIL

Dimension A (inches)	2.00
Dimension B (inches)	3.40
Weight (Lbs)	6.50
Lead Lengths (inches)	12

CAPACITOR

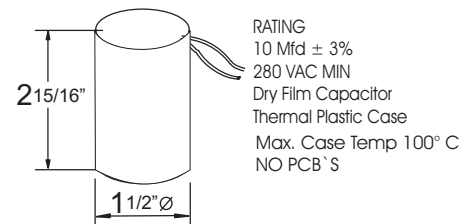

IGNITOR 37-63-AS-9.1-N7

Ballast to Lamp Distance (BTL): 2 feet

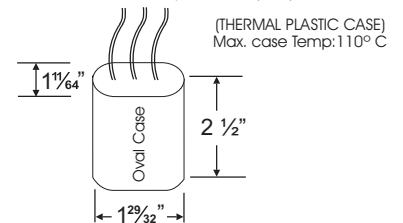

BRACKET CORE & COIL MOUNTING BRACKET

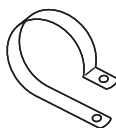
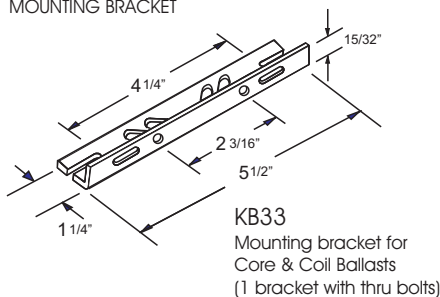

C-01
MOUNTING CLIP for round
case (Furnished as standard
with B suffix ballast)

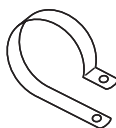

I-01
MOUNTING CLIP for oval
case (Furnished as standard
with B suffix ballast)

WIRING DIAGRAM

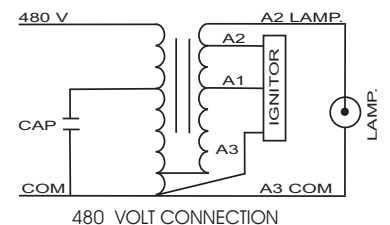

Data is based upon tests performed by Industrias Sola Basic in a controlled environment and representative of relative performance. Actual Performance can vary depending on operating conditions. Specifications are subject to change without notice.



Made in Mexico by Industrias Sola Basic S.A de C.V.

SOLA CANADA

LIGHTING & POWER

171 Ambassador Drive
Units 8 & 9
Mississauga, ON
L5T 2J1

Phone: 905-670-0746
Fax: 905-670-9689

www.solacanada.com