

CATALOG NUMBER: E-SIAFRMJ100 FOR ONE 100 WATT, S54 HIGH PRESSURE SODIUM LAMP

Line Voltage	120/208/240/347V
Regulation	
Line Volts	+/- 10%
Line Watts	WITHIN TRAPEZOID
Frequency	60 Hz
Circuit Type	CWI
Power Factor (min)	90%
Insulation Class	H(180°)
Min. Ambient Starting Temp.	-40° F or -40° C

Line Voltage (Volts)	120	208	240	347
Line Current (Amps)				
Operating	1.20	0.70	0.60	0.42
Open Circuit	0.72	0.41	0.37	0.25
Starting	0.64	0.37	0.32	0.22
Input Watts (W)	130	130	130	130
Open Circuit Voltage (V)	109	109	109	109
Drop Out Voltage (V)	80	130	150	230
UL(1029) Bench Top Rise	A	A	A	A
Recommended Fuse (Amps)	3	2	2	2

HIGH POTENTIAL TEST (VOLTS)	
1 Minute	2000
2 Seconds	2500
Open Circuit Voltage Test(volts)	100-125
Short-Circuit Current Test (Amps)	
Secondary Current	2.75 - 3.2

Input Current (Amps)	0.40 -	0.23 -	0.20 -	0.13 -
	0.55	0.30	0.26	0.18

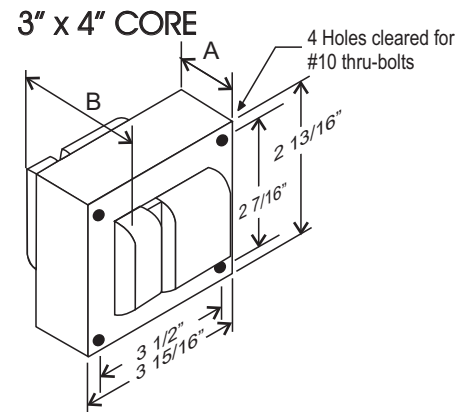

CORE AND COIL

Dimension A (inches)	2.40
Dimension B (inches)	3.80
Weight (Lbs)	8.10
Lead Lengths (inches)	12

CAPACITOR

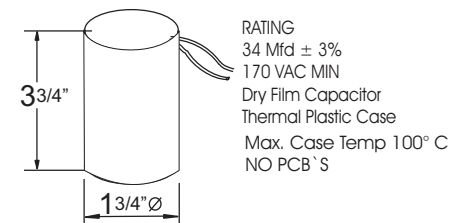

RATING
34 Mfd ± 3%
170 VAC MIN
Dry Film Capacitor
Thermal Plastic Case
Max. Case Temp 100° C
NO PCB'S

IGNITOR 37-63-AS-9.1-N7

Ballast to Lamp Distance (BTL): 2 feet

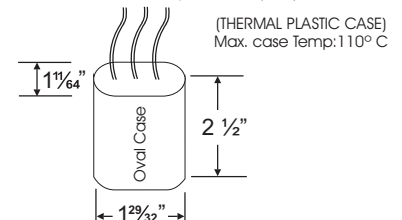

(THERMAL PLASTIC CASE)
Max. case Temp: 110° C

BRACKET CORE & COIL MOUNTING BRACKET

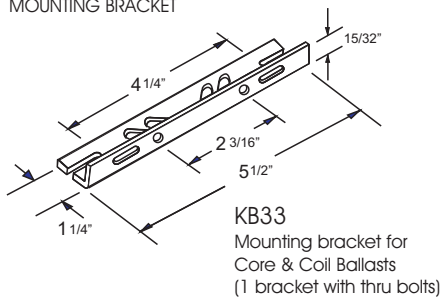

KB33
Mounting bracket for
Core & Coil Ballasts
(1 bracket with thru bolts)

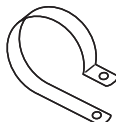

C-01
MOUNTING CLIP for round
case (Furnished as standard
with B suffix ballast)

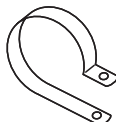

I-01
MOUNTING CLIP for oval
case (Furnished as standard
with B suffix ballast)

WIRING DIAGRAM

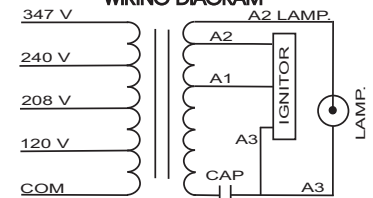

120/208/240/347 VOLT CONNECTION

Data is based upon tests performed by Industrias Sola Basic in a controlled environment and representative of relative performance. Actual Performance can vary depending on operating conditions. Specifications are subject to change without notice.



Certificate No. 006281



Made in Mexico by Industrias Sola Basic S.A de C.V.

SOLA CANADA

LIGHTING & POWER

171 Ambassador Drive
Units 8 & 9
Mississauga, ON
L5T 2J1

Phone: 905-670-0746
Fax: 905-670-9689

www.solacanada.com